

# SPECIFICATION FOR TFT MODULE

**MODULE NO: YB-TG1280800S15A-N-A0**

**Doc.Version:00**

Customer Approval:

<input type="checkbox"/> Accept	<input type="checkbox"/> Reject
---------------------------------	---------------------------------

YEEBO	NAME	SIGNATURE	DATE
Prepare	Electronic Engineer	黄松	2025-03-18
Check	Mechanical Engineer	张雷	2025/3/19
Verify			
Approval		孙五南	2025/3/19

■ APPROVAL FOR SPECIFICATIONS ONLY

□ APPROVAL FOR SPECIFICATIONS AND SAMPLE

WIMRD005-02-D



## **2. Table of Contents:**

<b>NO</b>	<b>CONTENTS</b>	<b>PAGE</b>
1	Revision History	1
2	Table of Contents	2
3	Module Numbering System	3
4	General Specification	4
5	LCM drawing	5
6	Electrical Characteristics	6
7	Optical Characteristics	17
8	Interface Pin Assignment	19
9	Block Diagram	21
10	Backlight Characteristics	22
11	Standard Specification for Reliability	23
12	Specification of Quality Assurance	25
13	Handling Precaution	31
14	Warranty	32
15	Guarantee	32

### 3. Module Numbering System:

(Example)

**YB- T G 240320 S 01 D -T - A0**

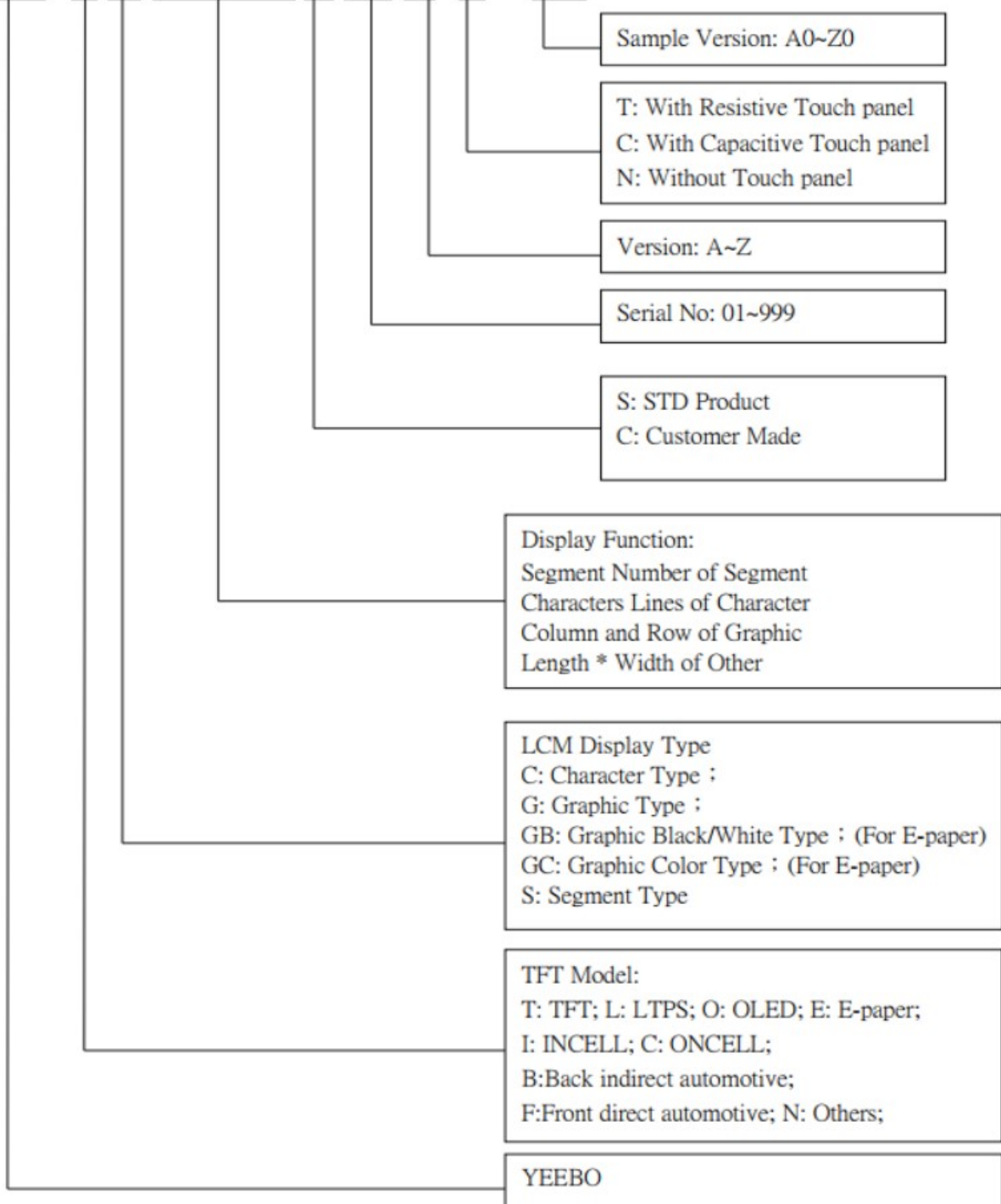

#### **4. General Specification:**

ITEM	CONTENTS
Module Size	228.8 (W) * 148.44 (H) * 4.53 (T) mm
Display Size(Diagonal)	10.1 inch
Display Format	1280(RGB) * 800 Pixels
Active Area	216.96 (W) * 135.6 (H) mm
Pixel Pitch	0.1695*0.1695 mm
LCD Type	16.7M Color / Transmissive / Normal Black
View Direction	Free
Controller IC	ILI6192 & ILI5801
Weight	TBD

## 5. LCM drawing:

Rec. 01	Count drawing & Spec. revision record during discussion with customer	Revision content description	Date
		FIRST ISSUE	2025-03-17

Customer Model

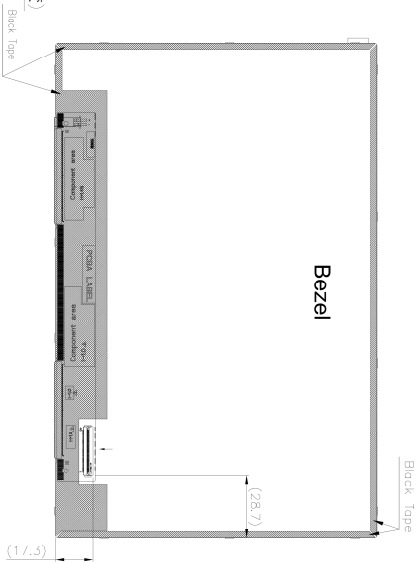
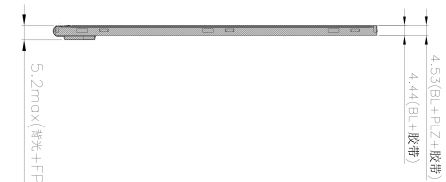
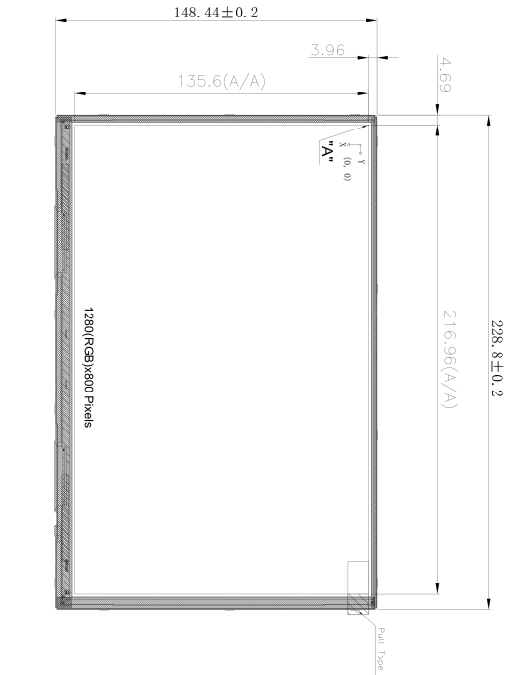

1	NC
2	VDD
3	VDD
4	NC
5	NC
6	NC
7	GND
8	RXIN0-
9	RXIN0+
10	GND
11	RXIN1-
12	RXIN1+
13	GND
14	RXIN2-
15	RXIN2+
16	GND
17	RXOLKIN-
18	RXOLKIN+
19	GND
20	RXIN3-
21	RXIN3+
22	GND
23	NC
24	NC
25	GND
26	NC
27	NC
28	NC
29	AVDD
30	GND
31	LED-
32	LED-
33	NC
34	NC
35	VG-
36	NC
37	NC
38	VG+
39	LED+
40	LED+

CIRCUIT DIAGRAM  
BL Electrical Circuit  
(V=18~22.4V, I=300mA)



- Specification:
1. Display mode: 10.1" TFT (16.7M)/ Normal Black/ Transmissive
  2. Viewing Direction: Free
  3. Backlight: LED White (X42):
  4. TFT Controller IC: ILI6192 & ILI5801 or Compatible
  5. Operating temperature: -20°C to +70°C  
Storage temperature: -30°C to +80°C
  6. Unspecified tolerance: ±0.30mm.
  7. RoHS compliant
  8. Luminous Intensity for LCM: 900 cd/m<sup>2</sup>(min), 1000 cd/m<sup>2</sup>(typ)
  9. 产品结构: TFT
  10. Connector type: 196479-40041-3 & FP225H-040611M;

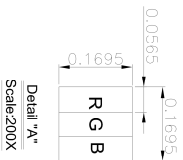

Detail "A-A"  
Scale:200X

		MOD. Name	YB-TG1280800S15A-N-A	DESIGNED	张雷	2025-03-13	CHECKED	VERIFIED	APPROVED	FILE NAME	Count Dwg.
		DESIGNED	张雷	2025-03-13	CHECKED	VERIFIED	APPROVED	FILE NAME	Count Dwg.		
UNIT	SIZE	SCALE	MOD. Name	DESIGNED	CHECKED	VERIFIED	APPROVED	FILE NAME	Sheet	1	
mm	A4	N-T-S	张雷	2025-03-13					Of	2	

## 6. Electrical Characteristics

### 6-1 Absolute Maximum Ratings

Item	Symbol	Values		Unit	Remark
		Min.	Max.		
Power voltage	VDD	-0.3	4	V	
	AVDD	-0.3	18	V	
	V <sub>GH</sub>	-0.3	42	V	
	V <sub>GL</sub>	-20	0.3	V	
	V <sub>GH</sub> -V <sub>GL</sub>	12	40	V	
Operation Temperature	T <sub>OP</sub>	-20	70	°C	
Storage Temperature	T <sub>ST</sub>	-30	80	°C	

Note 1: The absolute maximum rating values of this product are not allowed to be exceeded at any times. Should a module be used with any of the absolute maximum ratings exceeded, the characteristics of the module may not be recovered, or in an extreme case, the module may be permanently destroyed.

### 6-2 Operating Conditions

( Note 1 )

Item	Symbol	Values			Unit	Remark
		Min.	Typ.	Max.		
Power voltage	VDD	2.3	2.5	2.7	V	Note 2
	AVDD	8.0	8.2	8.4	V	
	V <sub>GH</sub>	12	12.5	13	V	
	V <sub>GL</sub>	-13.5	-13	-12.5	V	
Input signal voltage	VCOM	-	-	-	V	Note 3
Ripple voltage	VRP	-	-	150	mV	Note 4
Input logic high voltage	V <sub>IH</sub>	0.8 VDD	-	VDD	V	
Input logic low voltage	V <sub>IL</sub>	0	-	0.2 DV <sub>DD</sub>	V	

Note 1: Be sure to apply VDD and AVDD to the LCD first, and then apply V<sub>GH</sub> and V<sub>GL</sub>.

Note 2: VDD setting should match the signals output voltage of customer's system board.

Note 3: Auto Vcom, no Vcom voltage required.

Note 4: Including signal: VDD、AVDD、V<sub>GH</sub>、V<sub>GL</sub>



### 6-3 DC Characteristics

Item	Symbol	Values			Unit	Remark
		Min.	Typ.	Max.		
Current for Driver	$I_{GH}$	0.30	0.68	1.00	mA	$V_{GH} = 12.5V$
	$I_{GL}$	0.30	0.63	1.00	mA	$V_{GL} = -13V$
	$I_{V_{DD}}$	18.1	32.5	44.6	mA	$V_{DD} = 2.5V$
	$I_{AV_{DD}}$	46.7	72.1	115.9	mA	$AV_{DD} = 8.2V$

### Basic DC Characteristics

## 6-4 AC Characteristics

Parameter	Symbol	Values			Unit	Remark
		Min.	Typ.	Max.		
LVDS Differential input high Threshold voltage	$R_{xVTH}$	-	-	+200	mV	$R_{xVCM}=1.2V$
LVDS Differential input low Threshold voltage	$R_{xVTL}$	-200	-	-	mV	
LVDS Differential input common mode voltage	$R_{xVCM}$	1	1.2	$1.7 -  V_{ID} /2$	V	
LVDS Differential voltage	$ V_{ID} $	200	-	600	mV	

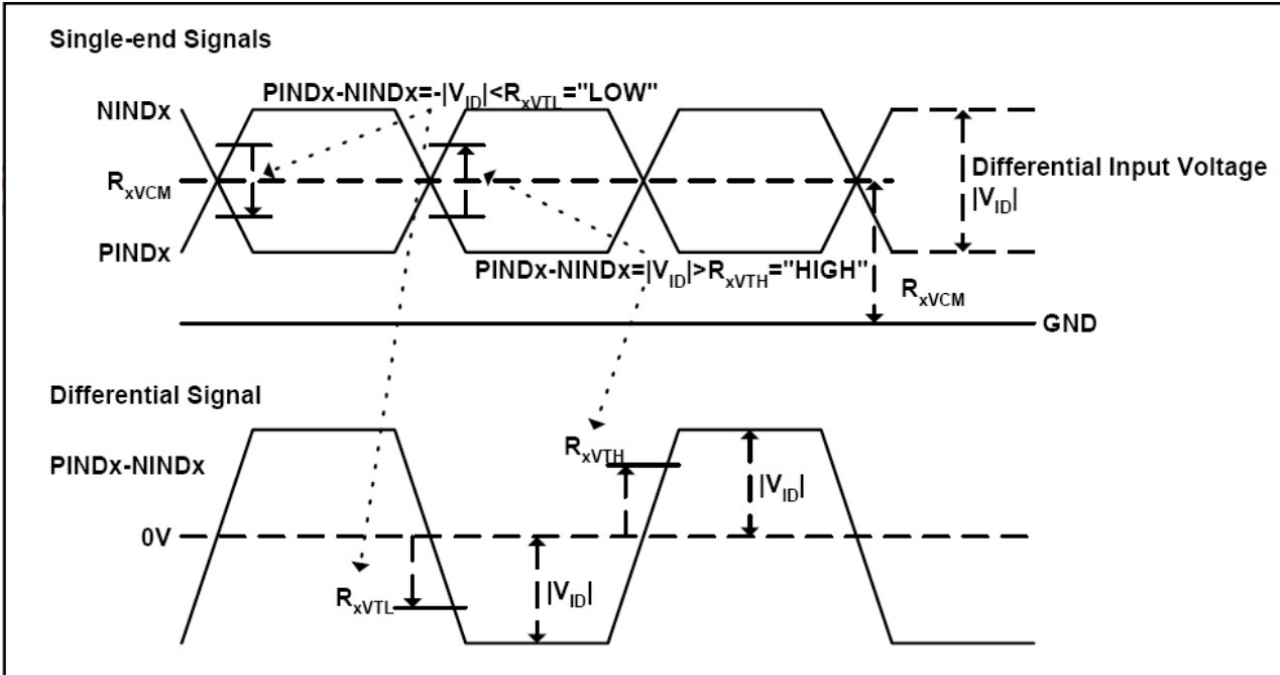

## 6-5 Power ON/OFF Sequence

### a. Power on:

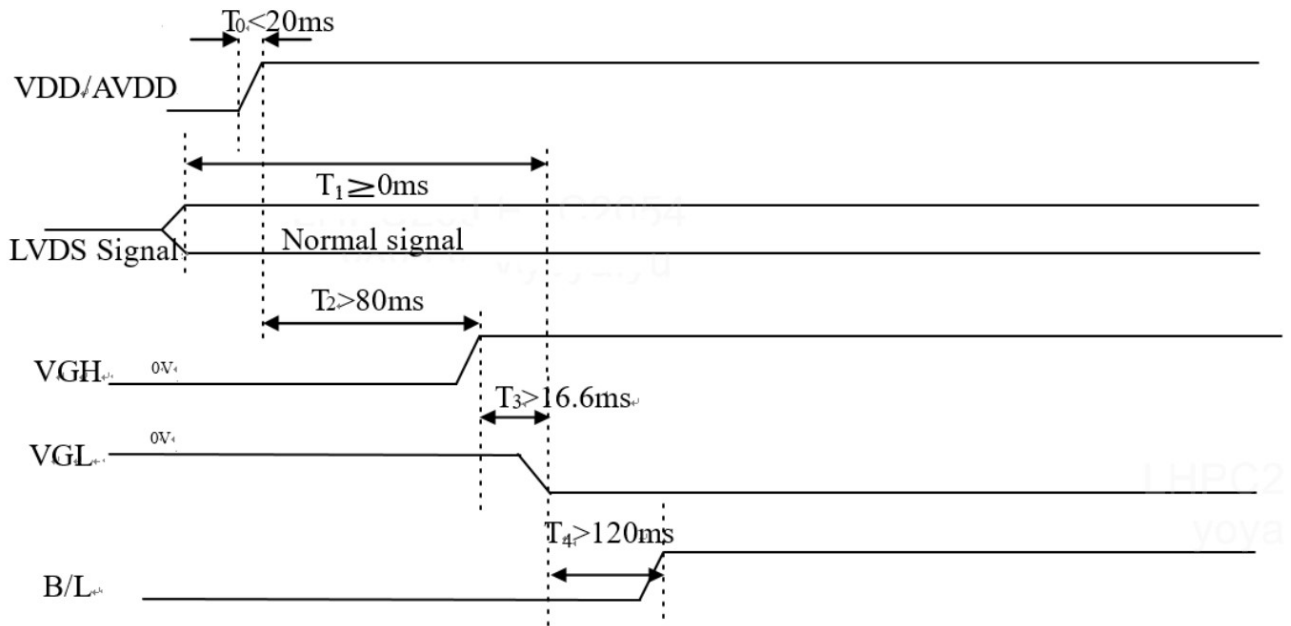

### b. Power off:

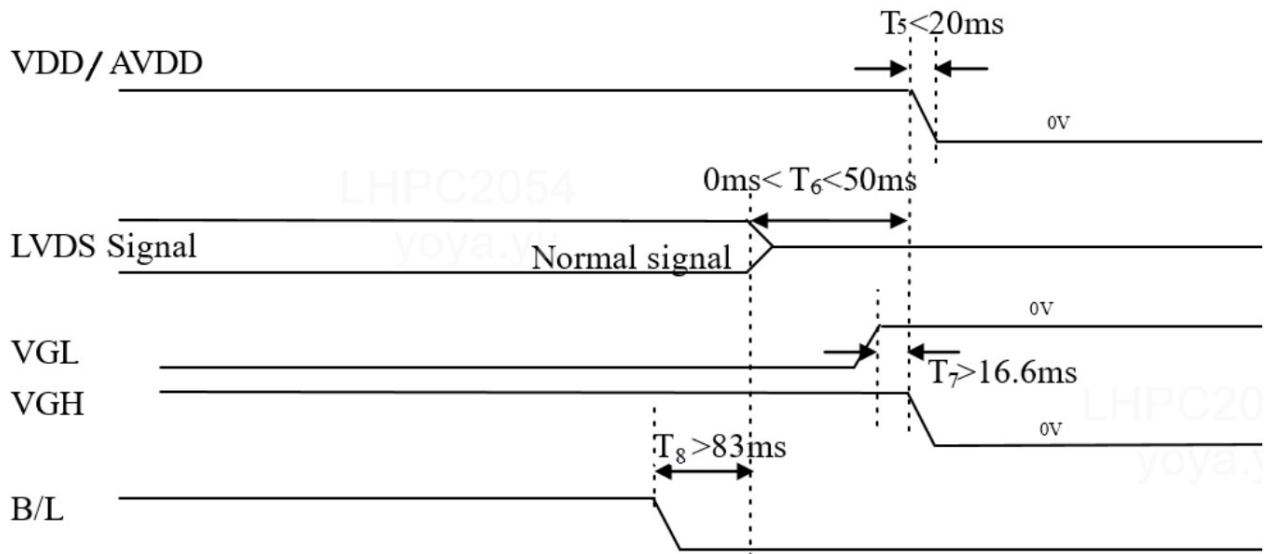

### 6-5 Timing Table

Item	Symbol	Values			Unit	Remark
		Min.	Typ.	Max.		
Clock Frequency	1/Tc	63.4	64.5	85.0	MHz	Frame rate =60Hz
Horizontal display area	t <sub>HD</sub>	1280				
HS period time	t <sub>H</sub>	1309	1322	1664	Tc	
HS Width +Back Porch +Front Porch	t <sub>HW</sub> + t <sub>HBP</sub> +t <sub>HFP</sub>	29	42	384	Tc	
Vertical display area	t <sub>VD</sub>	800				
VS period time	t <sub>V</sub>	807	813	1040	t <sub>H</sub>	
VS Width +Back Porch +Front Porch	t <sub>VW</sub> + t <sub>VBP</sub> +t <sub>VFP</sub>	7	13	240	t <sub>H</sub>	

Note1: Frame rate is 60 ± 5Hz, PCLK=Vtotal\*Htotal\*Frame Rate;

Note2: All the above conditions must be met.

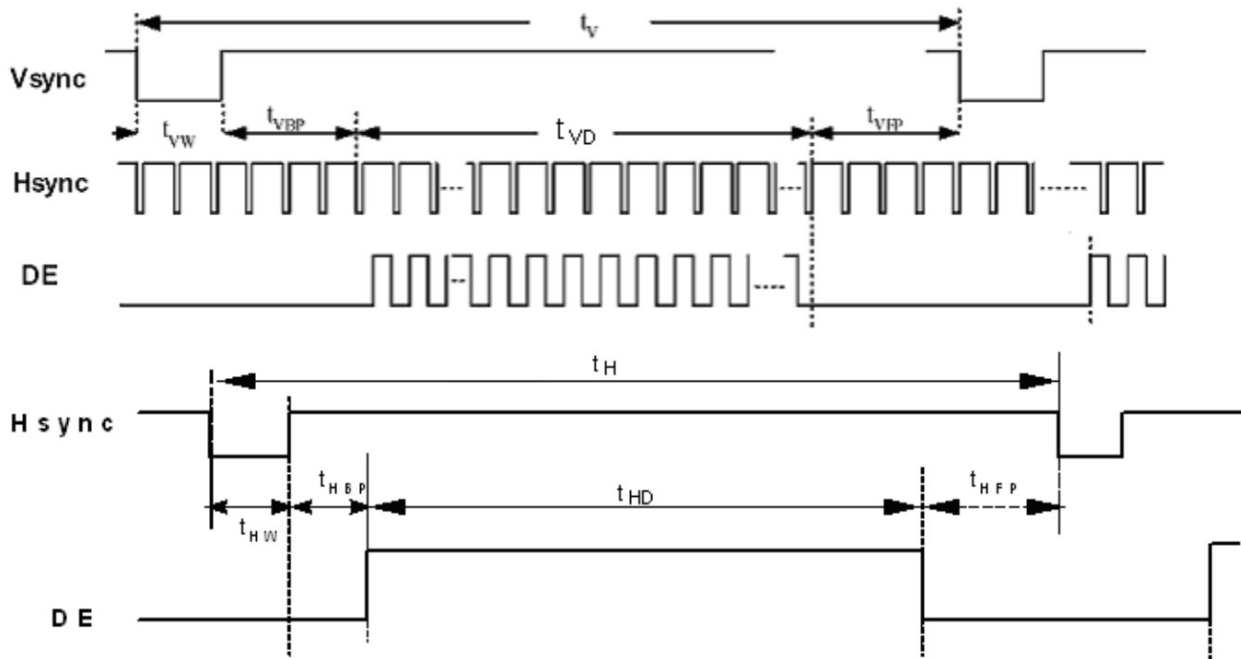

### 6-6 LVDS Data Input Format

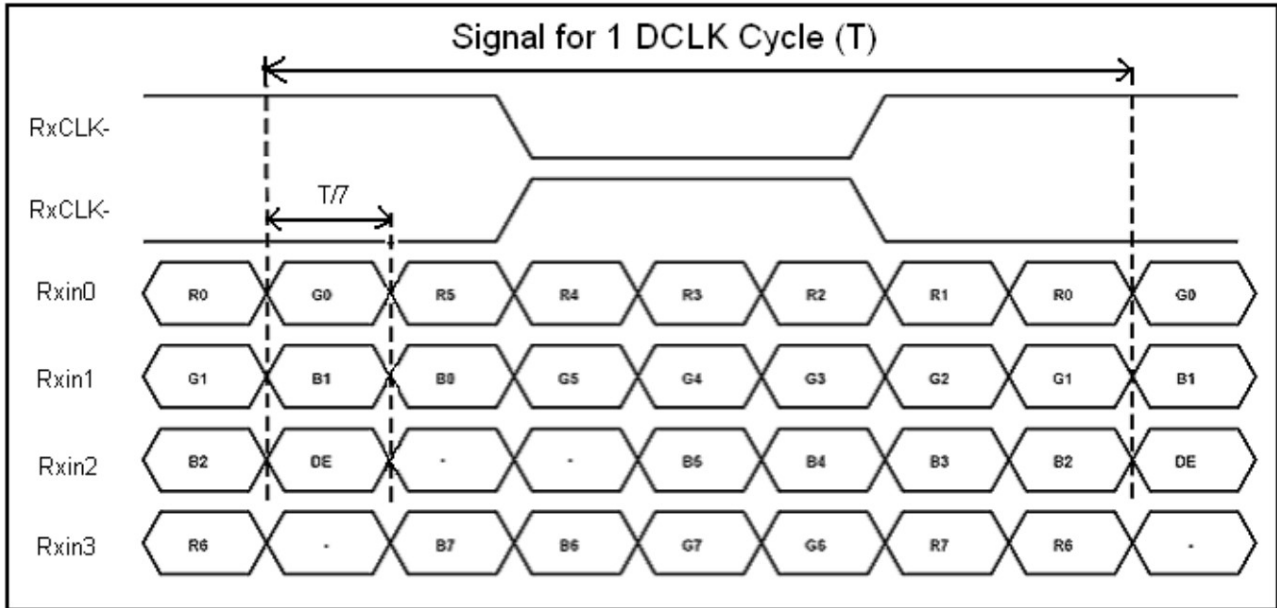

## 7. Optical Characteristics:

Item	Symbol	Conditions	Specifications			Unit	Note	
			Min	Typ	Max			
Transmittance	T(%)	-	5.52	6.27	-	-	-	
Contrast Ratio	CR	$\theta=0^\circ$ Normal Viewing Angle	600	800	-		(1) (2)	
Response time	TR+TF		-	35	50	ms	(1) (3)	
NTSC	-	-	-	-	-	%	Note 1	
Viewing Angle	Hor.	$\theta_{x+}$	CR $\geq$ 10	75	85	-	deg.	(1)
		$\theta_{x-}$		75	85	-		
	Ver.	$\theta_{y+}$		75	85	-		
		$\theta_{y-}$		75	85	-		

### Measuring Condition

1. Measuring surrounding: dark room
2. Ambient temperature:  $25\pm 2^\circ\text{C}$
3. 30 min. Warm-up time.

### Color of CIE Coordinate:

( $T_a=25^\circ\text{C}$ )

Item	Symbol	Condition	Min.	Typ.	Max.	
Chromaticity Coordinates (Transmissive)	Red	x	$\theta = \varphi = 0^\circ$ LED Backlight	TBD	TBD	TBD
		y		TBD	TBD	TBD
	Green	x		TBD	TBD	TBD
		y		TBD	TBD	TBD
	Blue	x		TBD	TBD	TBD
		y		TBD	TBD	TBD
	White	x		TBD	TBD	TBD
		y		TBD	TBD	TBD

Note (1) Definition of Viewing Angle :

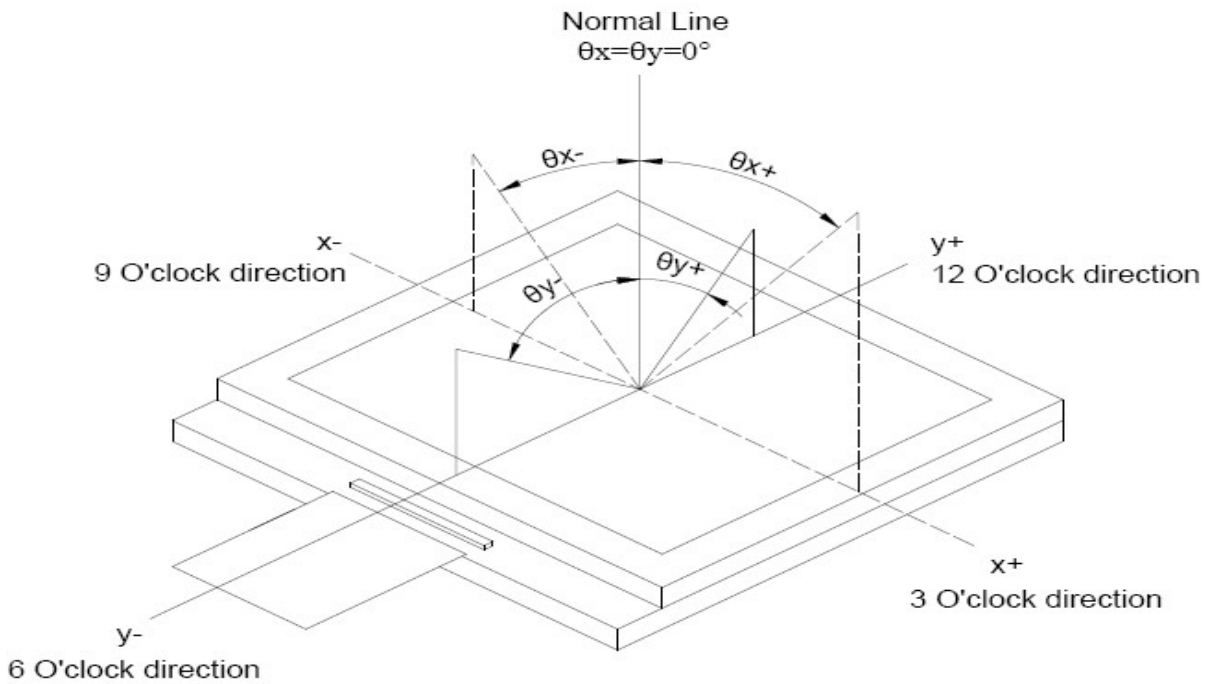

Note (2) Definition of Contrast Ratio(CR) :  
measured at the center point of panel

$$\text{Contrast ratio (CR)} = \frac{\text{Photo detector output when LCD is at "White" state}}{\text{Photo detector output when LCD is at "Black" state}}$$

Note (3) Definition of Response Time : Sum of TR and TF

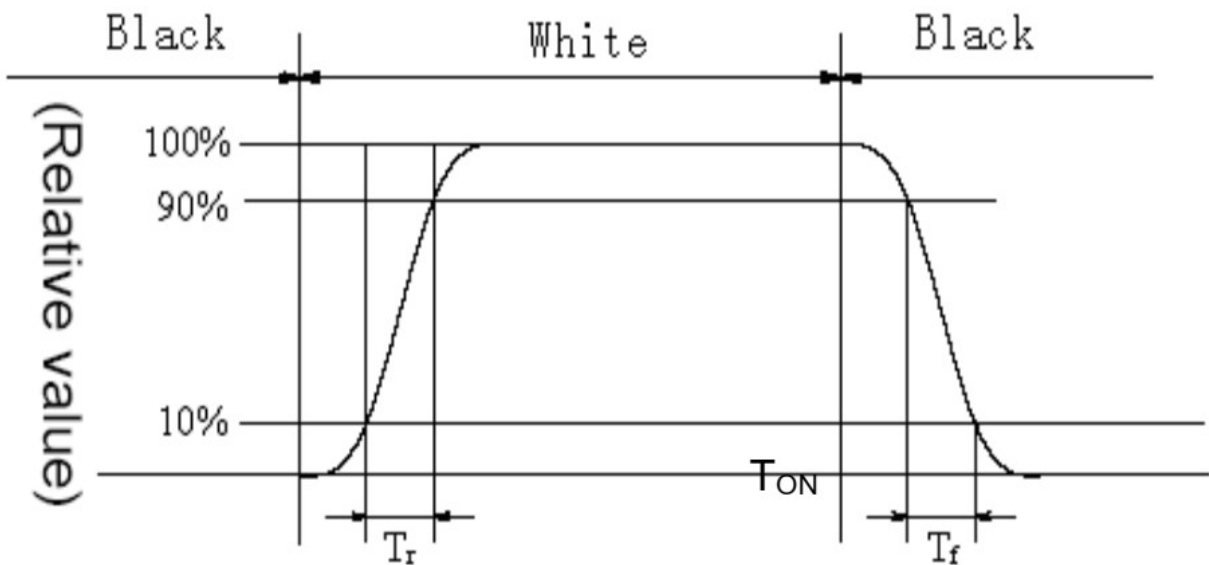

## 8. Interface Pin Assignment:

Pin No.	Symbol	I/O	Function	Remark
1	NC	---	No connection	
2	VDD	P	Power Supply	
3	VDD	P	Power Supply	
4	NC	---	Only INX test	
5	NC	---	Only INX test	
6	NC	---	Only INX test	
7	GND	P	Ground	
8	Rxin0-	I	-LVDS Differential Data Input	R0-R5, G0
9	Rxin0+	I	+LVDS Differential Data Input	
10	GND	P	Ground	
11	Rxin1-	I	-LVDS Differential Data Input	G1~G5, B0,B1
12	Rxin1+	I	+LVDS Differential Data Input	
13	GND	P	Ground	
14	Rxin2-	I	-LVDS Differential Data Input	B2-B5,HS,VS, DE
15	Rxin2+	I	+LVDS Differential Data Input	
16	GND	P	Ground	
17	RxCLK-	I	-LVDS Differential Clock Input	LVDS CLK
18	RxCLK+	I	+LVDS Differential Clock Input	
19	GND	P	Ground	
20	Rxin3-	I	-LVDS Differential Data Input	R6, R7, G6, G7, B6, B7
21	Rxin3+	I	+LVDS Differential Data Input	
22	GND	P	Ground	
23	NC	---	Only INX test	
24	NC	---	No connection	
25	GND	P	Ground	
26	NC	---	No connection	

27	NC	---	No connection	
28	NC	---	No connection	
29	AVDD	P	Power for Analog Circuit	
30	GND	P	Ground	
31	LED-	P	LED Cathode	
32	LED-	P	LED Cathode	
33	NC	---	Only INX test	
34	NC	---	No connection	
35	VGL	P	Gate OFF Voltage	
36	NC	---	No connection	
37	NC	---	No connection	
38	VGH	P	Gate ON Voltage	
39	LED+	P	LED Anode	
40	LED+	P	LED Anode	

I: input, O: output, P: Power

**9. Block Diagram:**

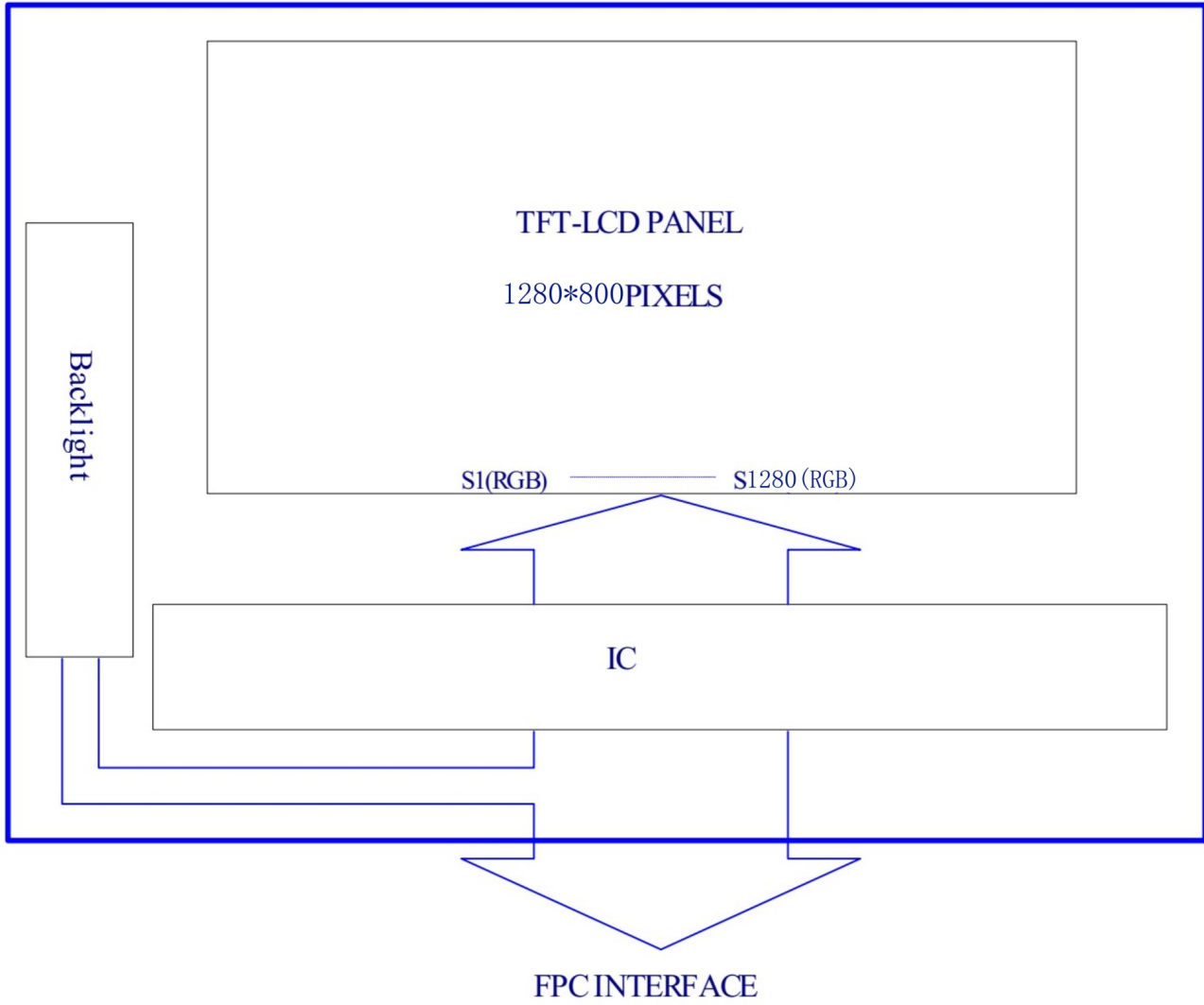

## 10. Backlight:

1. Standard Lamp Styles (Edge Lighting Type):  
The LED chips are distributed over the edge light area of the illumination unit, which gives the less power consumption:
2. The Main Advantages of the LED Backlight are as following:
  - 2.1 The brightness of the backlight can simply be adjusted.  
By a resistor or a potentiometer.

### 3. Data About LED Backlight:

(Ta=25°C)

PARAMETER	Sym.	Min.	Typ.	Max.	Unit	Test Condition	Note
Supply Current	I	-	300	-	mA		
Supply Voltage	V	18.9	21	22.4	V	If=300mA	
Luminous Intensity for LCM	IV	900	1000	-	cd/m <sup>2</sup>		2
Uniformity for LCM	-	75	-	-	%		3
Life Time	-	20000	-	-	Hr.		4
Color	White						

NOTE:

1. Backlight Only
2. Average Luminous Intensity of P1-P9
3. Uniformity = Min/Max \* 100%
4. LED life time defined as follows: The final brightness is at 50% of original brightness

**Measured Method: (X\*Y: Light Area)**

**Internal Circuit Diagram**

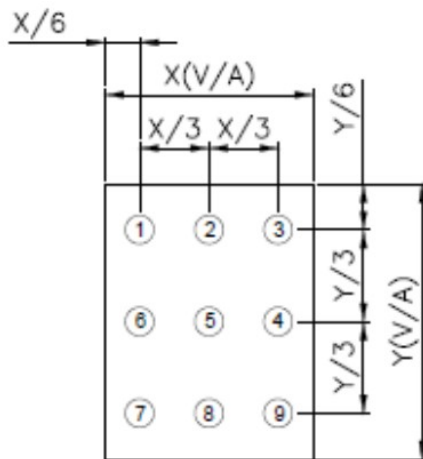

**(Effective spatial Distribution)**

Using aperture of 1°, distance 50cm

## 11. Standard Specification for Reliability:

### 11-1. Standard Specifications for Reliability of LCD Module

No	Item	Description
01	High temperature operation	The sample should be allowed to stand at 70°C for 240 hours under driving condition and then returning it to normal temperature condition, and allowing it stand for 2 hours.
02	Low temperature operation	The sample should be allowed to stand at -20°C for 240 hours under driving condition and then returning it to normal temperature condition, and allowing it stand for 2 hours.
03	High temperature storage	The sample should be allowed to stand at 80°C for 240 hours under no-load condition, and then returning it to normal temperature condition, and allowing it stand for 2 hours.
04	Low temperature storage	The sample should be allowed to stand at -30°C for 240 hours under no-load condition, then returning it to normal temperature condition, and allowing it stand for 2 hours.
05	Moisture storage	The sample should be allowed to stand at 60°C,90%RH MAX for 240 hours under no-load condition, then taking it out and drying it at normal temperature for 2 hours.
06	Thermal shock storage	The sample should be allowed to stand the following 10 cycles : -20°C for 30 minutes → normal temperature for 5 minutes → +60°C for 30 minutes → normal temperature for 5 minutes, as one cycle.
07	Packing vibration	Frequency range : 10Hz ~ 55Hz Amplitude of vibration : 1.5mm      Sweep time: 12 min X,Y,Z 2 hours for each direction.
08	Packing drop test	According to ISTA 1A 2001.
09	Electrical Static Discharge	Air: ±4KV 150pF/330Ω 5 times
		Contact: ±2KV 150pF/330Ω 5 time

\*Sample size for each test item is 3~5pcs



11 - 2. Testing Conditions and Inspection Criteria

For the final test the testing sample must be stored at room temperature for 24 hours, after the tests listed in Table 11.2, Standard specifications for Reliability have been executed in order to ensure stability.

No	Item	Test Model	In section Criteria
01	Current Consumption	Refer To Specification	The current consumption should conform to the product specification.
02	Contrast	Refer To Specification	After the tests have been executed, the contrast must be larger than half of its initial value prior to the tests.
03	Appearance	Visual inspection	Defect free.

11- 3. MTBF

MTBF	Functions, performance, appearance, etc. shall be free from remarkable deterioration within 50,000 hours under ordinary operating and storage conditions room temperature (25±5°C), normal humidity (50±10% RH), and in area not exposed to direct sun light.
------	---------------------------------------------------------------------------------------------------------------------------------------------------------------------------------------------------------------------------------------------------------------

## 12. Specification of Quality Assurance:

### 12-1. Purpose

This standard for Quality Assurance should affirm the quality of LCD module products to supply to purchaser by YEEBO CORPORATION (Supplier).

### 12-2. Standard for Quality Test

#### a. Inspection:

Before delivering, the supplier should take the following tests, and affirm the quality of product.

#### b. Electro-Optical Characteristics:

According to the individual specification to test the product.

#### c. Test of Appearance Characteristics:

According to the individual specification to test the product.

#### d. Test of Reliability Characteristics:

According to the definition of reliability on the specification for testing products.

#### e. Delivery Test:

Before delivering, the supplier should take the delivery test.

(i) Test method: According to **ISO2859-1**.General Inspection Level II take a single time.

(ii) The defects classify of AQL as following:

Major defect: AQL =0.65

Minor defect: AQL =2.5

Total defects: AQL =2.5

### 12-3. Non- conforming Analysis & Deal with Manners

#### a. Non- conforming Analysis:

(i) Purchaser should supply the detail data of non- conforming sample and the non-conforming.

(ii) After accepting the detail data from purchaser, the analysis of non- conforming should be finished in two weeks.

(iii) If supplier can not finish analysis on time, must announce purchaser before 3 days.

#### b. Disposition of non- conforming:

(i) If find any product defect of supplier during assembly time, supplier must change the good product for every defect after recognition.

(ii) Both supplier and customer should analyze the reason and discuss the disposition of non- conforming when the reason of nonconforming is not sure.

### 12-4. Agreement items

Both sides should discuss together when the following problems happen.

a. There is any problem of standard of quality assurance, and both sides should think that must be modified.

b. There is any argument item which does not record in the standard of quality assurance.

c. Any other special problem.

12-5. Standard of the Product Appearance Test

a. Manner of appearance test:

(i) Illumination: External Appearance Inspection :  $1000 \pm 200$  Lux ; Light on inspection :  $200 \pm 50$  Lux.

(ii) To be a distance about  $30 \pm 5$  cm in front of LCD unit, viewing line should be perpendicular to the surface of the module judge the visual appearance with human's eyes.

(iii) Scope of inspection perspective:

The inspection angle of IPS screen is within  $\pm 30^\circ$  of the vertical line on the product surface; The TN screen inspection angle is  $-15^\circ$  from the vertical line of the product surface in the 12 o'clock direction to  $30^\circ$  from the vertical line of the product surface in the 6 o'clock direction.

(iii) Temperature:  $25 \pm 5^\circ\text{C}$  Humidity:  $60 \pm 10\% \text{RH}$

IPS:

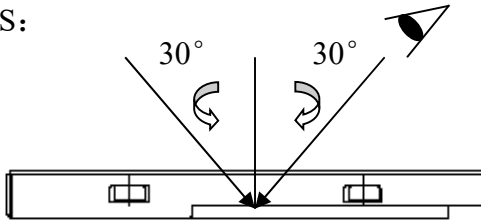

TN:

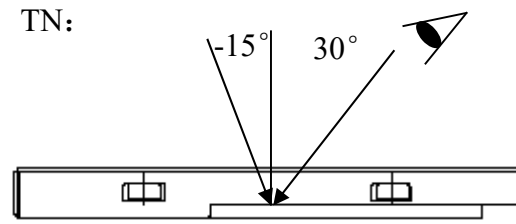

(iv) Definition of area:

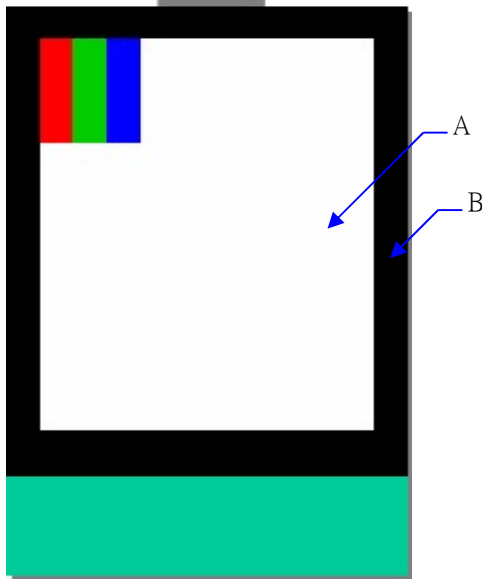

A. Area: Viewing area.

B. Area: Out of viewing area.

(Outside viewing area)

b. Basic principle:

(i) It will accord to the AQL when the standard cannot be described.

(ii) The sample of the lowest acceptable quality level must be discussed by both supplier and customer when any dispute happened.

(iii) Must add new item on time when it is necessary.

c. Standard of inspection: (Unit: mm)

**12-6. Inspection specification**

Defect out of viewing area can be neglected.

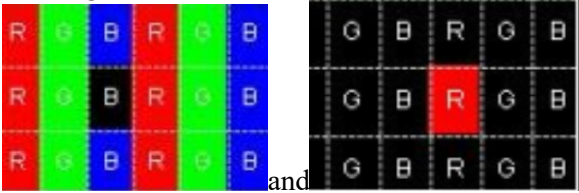
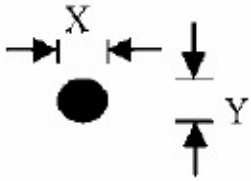
NO	Item	Criterion	AQL														
01	Electrical Testing	1.1 Missing vertical, horizontal segment, segment contrast defect. 1.2 Missing character, dot or icon. 1.3 Display malfunction. 1.4 No function or no display. 1.5 Current consumption exceeds product specifications. 1.6 LCD viewing angle defect. 1.7 Mixed product types.	0.65														
02	Pixel Defect	2.1 Bright and Black dot define:  and Pixel Defect as below drawing: <table border="1"> <thead> <tr> <th>Type</th> <th>Acceptable Q'ty</th> </tr> </thead> <tbody> <tr> <td>Bright Dot</td> <td><math>N \leq 2</math></td> </tr> <tr> <td>Two bright dots</td> <td><math>N \leq 0</math></td> </tr> <tr> <td>Dark Dot</td> <td><math>N \leq 4</math></td> </tr> <tr> <td>Two Dark dots</td> <td><math>N \leq 1</math></td> </tr> <tr> <td>Three Dark dots</td> <td><math>N \leq 0</math></td> </tr> <tr> <td>Total(Bright+Dark dot)</td> <td><math>N \leq 4</math></td> </tr> </tbody> </table> *Densely spaced: No more than two spots within 10mm.	Type	Acceptable Q'ty	Bright Dot	$N \leq 2$	Two bright dots	$N \leq 0$	Dark Dot	$N \leq 4$	Two Dark dots	$N \leq 1$	Three Dark dots	$N \leq 0$	Total(Bright+Dark dot)	$N \leq 4$	2.5
Type	Acceptable Q'ty																
Bright Dot	$N \leq 2$																
Two bright dots	$N \leq 0$																
Dark Dot	$N \leq 4$																
Two Dark dots	$N \leq 1$																
Three Dark dots	$N \leq 0$																
Total(Bright+Dark dot)	$N \leq 4$																
03	LCD , Touch Panel and Backlight  Black and white spots/lines contamination  (Foreign Material)	3.1 Dot type: As following drawing $\Phi = (X+Y) / 2$  <table border="1"> <thead> <tr> <th>Size(mm)</th> <th>Acceptable Q'ty</th> </tr> </thead> <tbody> <tr> <td><math>\Phi \leq 0.20</math></td> <td>Accept no dense</td> </tr> <tr> <td><math>0.20 &lt; \Phi \leq 0.40</math></td> <td>3</td> </tr> <tr> <td><math>0.40 &lt; \Phi</math></td> <td>0</td> </tr> </tbody> </table> 3.1.1 Not visible through 5% ND filter 3.1.2 Densely spaced: No more than two spots within 5mm. 3.1.3 This is acceptable when surface dirt can be removed by wiping.	Size(mm)	Acceptable Q'ty	$\Phi \leq 0.20$	Accept no dense	$0.20 < \Phi \leq 0.40$	3	$0.40 < \Phi$	0	2.5						
Size(mm)	Acceptable Q'ty																
$\Phi \leq 0.20$	Accept no dense																
$0.20 < \Phi \leq 0.40$	3																
$0.40 < \Phi$	0																
		3.2 Tiny bright dot、Dense tiny highlights: Definition of Tiny bright dot: $\Phi < 0.20\text{mm}$ ; Ignore, clustered is not allowed( $N \leq 5, D \leq 5$ )  *Not visible through 5% ND filter	2.5														

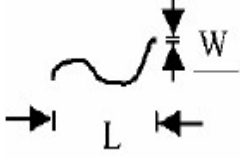
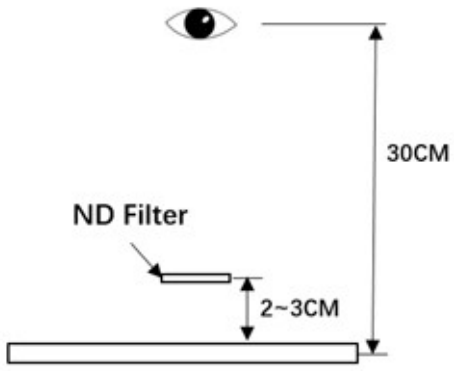
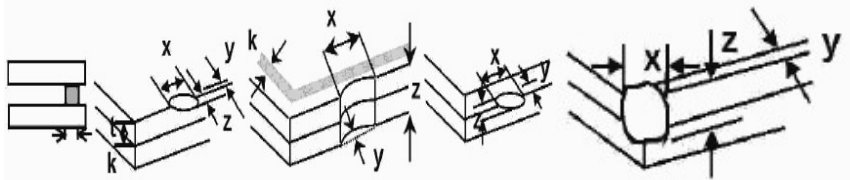
NO	Item	Criterion	AQ L												
03	LCD , Touch Panel and Backlight  Black and white spots/lines contamination (Foreign Material)	<p>3.3 Line type: (As following drawing)</p>  <table border="1" data-bbox="758 257 1332 481"> <thead> <tr> <th>Length(mm)</th> <th>Width(mm)</th> <th>Acceptable Q'ty</th> </tr> </thead> <tbody> <tr> <td>---</td> <td><math>W \leq 0.03</math></td> <td>Accept no dense</td> </tr> <tr> <td><math>L \leq 5.0</math></td> <td><math>0.03 &lt; W \leq 0.10</math></td> <td>3</td> </tr> <tr> <td>---</td> <td><math>0.10 &lt; W</math></td> <td>Rejection</td> </tr> </tbody> </table> <p>* Densely spaced: No more than two spots within 5mm.</p>	Length(mm)	Width(mm)	Acceptable Q'ty	---	$W \leq 0.03$	Accept no dense	$L \leq 5.0$	$0.03 < W \leq 0.10$	3	---	$0.10 < W$	Rejection	2.5
Length(mm)	Width(mm)	Acceptable Q'ty													
---	$W \leq 0.03$	Accept no dense													
$L \leq 5.0$	$0.03 < W \leq 0.10$	3													
---	$0.10 < W$	Rejection													
04	Polarizer bubbles	<p>If bubbles are visible, Judge using black spot specifications, not easy to find, must check in specify direction.</p> <table border="1" data-bbox="742 694 1332 873"> <thead> <tr> <th>Size <math>\Phi</math>(mm)</th> <th>Acceptable Q'ty</th> <th>Area</th> </tr> </thead> <tbody> <tr> <td><math>\Phi \leq 0.25</math></td> <td>Accept no dense</td> <td>V.A</td> </tr> <tr> <td><math>0.25 &lt; \Phi \leq 1.00</math></td> <td>3</td> <td>V.A</td> </tr> <tr> <td><math>1.00 &lt; \Phi</math></td> <td>0</td> <td>V.A</td> </tr> </tbody> </table> <p>* Densely spaced: No more than two spots within 5mm. * Outside of the V.A. is disregard.</p>	Size $\Phi$ (mm)	Acceptable Q'ty	Area	$\Phi \leq 0.25$	Accept no dense	V.A	$0.25 < \Phi \leq 1.00$	3	V.A	$1.00 < \Phi$	0	V.A	2.5
Size $\Phi$ (mm)	Acceptable Q'ty	Area													
$\Phi \leq 0.25$	Accept no dense	V.A													
$0.25 < \Phi \leq 1.00$	3	V.A													
$1.00 < \Phi$	0	V.A													
05	Mura	<p>Not visible through 5% ND filter.</p> <p>*ND card is 2~3cm from the panel, human eye is 30±5cm from the panel; The line of sight is moved to the ND card for judgment: if it is not visible for 2-3 seconds - OK, visible – NG</p> 	2.5												
06	Chipped glass	<p>Symbols: x: Chip length      y: Chip width      z: Chip thickness k: Seal width                  t: Single-layer glass thickness a: LCD side length      L: Electrode pad length</p> <p>8.1 Chip on panel surface and crack between panels and Corner crack:</p>  <table border="1" data-bbox="391 1736 1212 1836"> <tbody> <tr> <td>z: Chip thickness</td> <td>y: Chip width</td> <td>x: Chip length</td> </tr> <tr> <td><math>z \leq t</math></td> <td>Not over BM glue area</td> <td><math>x \leq 1/8a</math></td> </tr> </tbody> </table> <p>⊙ Unit: mm ⊙ If there are 2 or more chips, x is the total length of each chip. ⊙ If there chipped area touches the ITO terminal, over 2/3 of the ITO must remain and do not affect the function.</p>	z: Chip thickness	y: Chip width	x: Chip length	$z \leq t$	Not over BM glue area	$x \leq 1/8a$	2.5						
z: Chip thickness	y: Chip width	x: Chip length													
$z \leq t$	Not over BM glue area	$x \leq 1/8a$													

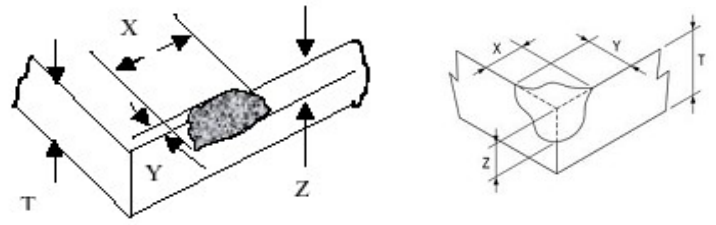
NO	Item	Criterion	AQL								
07	Scratches	Follow NO.3 -3 Line Type.	2.5								
08	Cracked glass	The LCD with extensive crack is not acceptable.	2.5								
09	Backlight elements	9.1 Illumination source flickers when lit. 9.2 Spots or scratches that appear when lit must be judged. Using LCD spot, lines and contamination standards. 9.3 Backlight doesn't light or color is wrong.	2.5 2.5 0.65								
10	Bezel	Bezel must comply with product specifications.	2.5								
11	PCB、COB	11.1 COB seal may not have pinholes larger than 0.2mm or contamination. 11.2 COB seal surface may not have pinholes through to the IC. 11.3 The height of the COB should not exceed the height indicated in the assembly diagram. 11.4 There may not be more than 2mm of sealant outside the seal area on PCB. And there should be no more than three places. 11.5 Parts on PCB must be the same as on the production characteristic chart, There should be no wrong parts, missing parts or excess parts. 11.6 The jumper on the PCB should conform to the product characteristic chart. 11.7 PCBA cosmetic control base on latest IPC standard, IPC-A-610, acceptable limit of grade 2.	2.5 2.5 2.5 2.5 0.65 0.65 2.5								
12	FPC	Affect function rejection, do not affect function acceptance.	2.5								
13	Soldering	13.1 No cold solder joints, missing solder connections, oxidation or icicle. 13.2 No short circuits in components on PCB or FPC.	2.5 0.65								
14	Touch Panel Chipped glass	Edge breakage can't affect visual effect (edge breakage can't cause damage to circuit); over lens have no visual damage   <table border="1" data-bbox="351 1803 1268 1960"> <thead> <tr> <th>x: Chip length</th> <th>y: Chip width</th> <th>z: Chip thickness</th> <th>Acceptable numbers</th> </tr> </thead> <tbody> <tr> <td><math>x \leq 3\text{mm}</math></td> <td><math>Y \leq 2\text{mm}</math></td> <td><math>z \leq t</math></td> <td>2</td> </tr> </tbody> </table>	x: Chip length	y: Chip width	z: Chip thickness	Acceptable numbers	$x \leq 3\text{mm}$	$Y \leq 2\text{mm}$	$z \leq t$	2	2.5
x: Chip length	y: Chip width	z: Chip thickness	Acceptable numbers								
$x \leq 3\text{mm}$	$Y \leq 2\text{mm}$	$z \leq t$	2								

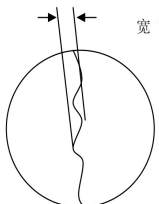
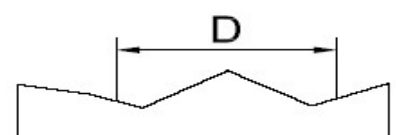
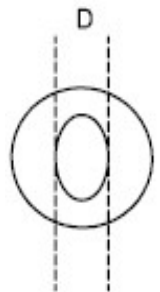
NO	Item	Criterion	AQL								
15	V/A printed edges sawtooth inspected according to this standard  LOGO's sawtooth	<p>Some contentious defect judged according to samples.</p> <table border="1"> <thead> <tr> <th>Product type</th> <th>Conditions</th> </tr> </thead> <tbody> <tr> <td>Same size</td> <td>1、width below 0.2mm (included) ignored, above 0.2mm NG 2、 Length not accounted</td> </tr> </tbody> </table> 	Product type	Conditions	Same size	1、width below 0.2mm (included) ignored, above 0.2mm NG 2、 Length not accounted	2.5				
Product type	Conditions										
Same size	1、width below 0.2mm (included) ignored, above 0.2mm NG 2、 Length not accounted										
16	Touch Panel(Fish eye、dent and bubble on film)	<table border="1"> <thead> <tr> <th>SIZE(mm)</th> <th>Acceptable Q'ty</th> </tr> </thead> <tbody> <tr> <td><math>\Phi \leq 0.2</math></td> <td>Accept no dense</td> </tr> <tr> <td><math>0.2 &lt; D \leq 0.70</math></td> <td>4</td> </tr> <tr> <td><math>0.70 &lt; D</math></td> <td>0</td> </tr> </tbody> </table>  	SIZE(mm)	Acceptable Q'ty	$\Phi \leq 0.2$	Accept no dense	$0.2 < D \leq 0.70$	4	$0.70 < D$	0	2.5
SIZE(mm)	Acceptable Q'ty										
$\Phi \leq 0.2$	Accept no dense										
$0.2 < D \leq 0.70$	4										
$0.70 < D$	0										
17	Touch Panel Newton ring	Newton ring dimension $\leq 1/2$ touch panel area and not affect font and line distortion ( $\leq 2.5\%$ ), it is acceptable.	2.5								
18	Touch Panel Linearity	Less than 2.5% is acceptable.	2.5								
19	LCD Ripple	Touch the touch panel, cannot see the LCD ripple. Pen: R 1.0mm silicon rubber. Operation Force: 80g	2.5								
20	General appearance	20.1 Product packaging must the same as specified on packaging specification sheet. 20.2 Product dimension and structure must conform to product Specification sheet.	0.65 0.65								

## 13. Handling Precaution:

### 13-1 Handling of LCM

- Don't give external shock.
- Don't apply excessive force on the surface.
- Liquid in LCD is hazardous substance. Must not lick and swallow. When the liquid is attach to your hand, skin, cloth etc. Wash it out thoroughly and immediately.
- Don't operate it above the absolute maximum rating.
- Don't disassemble the LCM.
- The operators should be grounded whenever he/she comes into contact with the module. Never touch any of the conductive parts such as the LSI pads, the copper leads on the PCB and the interface terminals with any parts of the human body.
- The modules should be kept in antistatic bags or other containers resistant to static for storage.
- The module is coated with a film to protect the display surface. Be care when peeling off this protective film since static electricity may be generated.

### 13-2 Storage

- Store in an ambient temperature of  $25\pm 10^{\circ}\text{C}$ , and in a relative humidity of  $50\pm 10\%\text{RH}$ . Don't expose to sunlight or fluorescent light.
- Storage in a clean environment, free from dust, active gas, and solvent.
- Store in anti-static electricity container.
- Store without any physical load.

### 13-3 Soldering

- Use only soldering irons with proper grounding and no leakage.
- Iron: No higher than  $310\pm 10^{\circ}\text{C}$  and less than 3 sec during Hand soldering.
- Rewiring: no more than 2 times.

## 14. Warranty

This product has been manufactured to specifications as a part for use in your company's general electronic products. It is guaranteed to perform according to delivery specifications. For any other use apart from general electronic equipment, we will not take responsibility if the product is used in medical devices, nuclear power control equipment, aerospace equipment, fire and security systems, or any other applications in which there is a direct risk to human life and where extremely high levels of reliability are required. If the product is to be used in any of the above applications, we will need to enter into a separate product liability agreement.

1. We cannot accept responsibility for any defect arise after additional process of the product (Including disassembly and reassembly), after product delivery.
2. We cannot accept responsibility for any defect, which may arise after the application of strong External force to the product.
3. We cannot accept responsibility for any defect, which may arise due to the application of static Electricity after the product has passed your company's acceptance inspection procedures.
4. We cannot accept responsibility for industrial property, which may arise through the use of your product, with exception to those issues relating directly to the structure or method of manufacturing of our product within one year from YEEBO shipment.
5. For Heatseal Product which required to heatseal by customer side, parts must be used within three months after delivery from factory.
6. For TAB Product which required to solder by customer side, parts must be used within three Months after delivery from factory.
7. The liability of YB is limited to repair or replacement on the terms set forth below. YB will not be responsible for any subsequent or consequential events or injury or damage to any personnel or user including third party personnel and/or user. Unless otherwise agreed in writing between YB and the customer, YB will only replace or repair any of its LCD which is found defective electrically or visually when inspected in accordance with YB GENERAL LCD INSPECTION STANDARD.

## 15. Guarantee:

Our products meet requirements of the environment.

YEEBO ROHS requirement is based on European Union Directive 2011/65/EU (ROHS) Requirements and Update.